

R&S® TS-PMB Matrix Module B User Manual

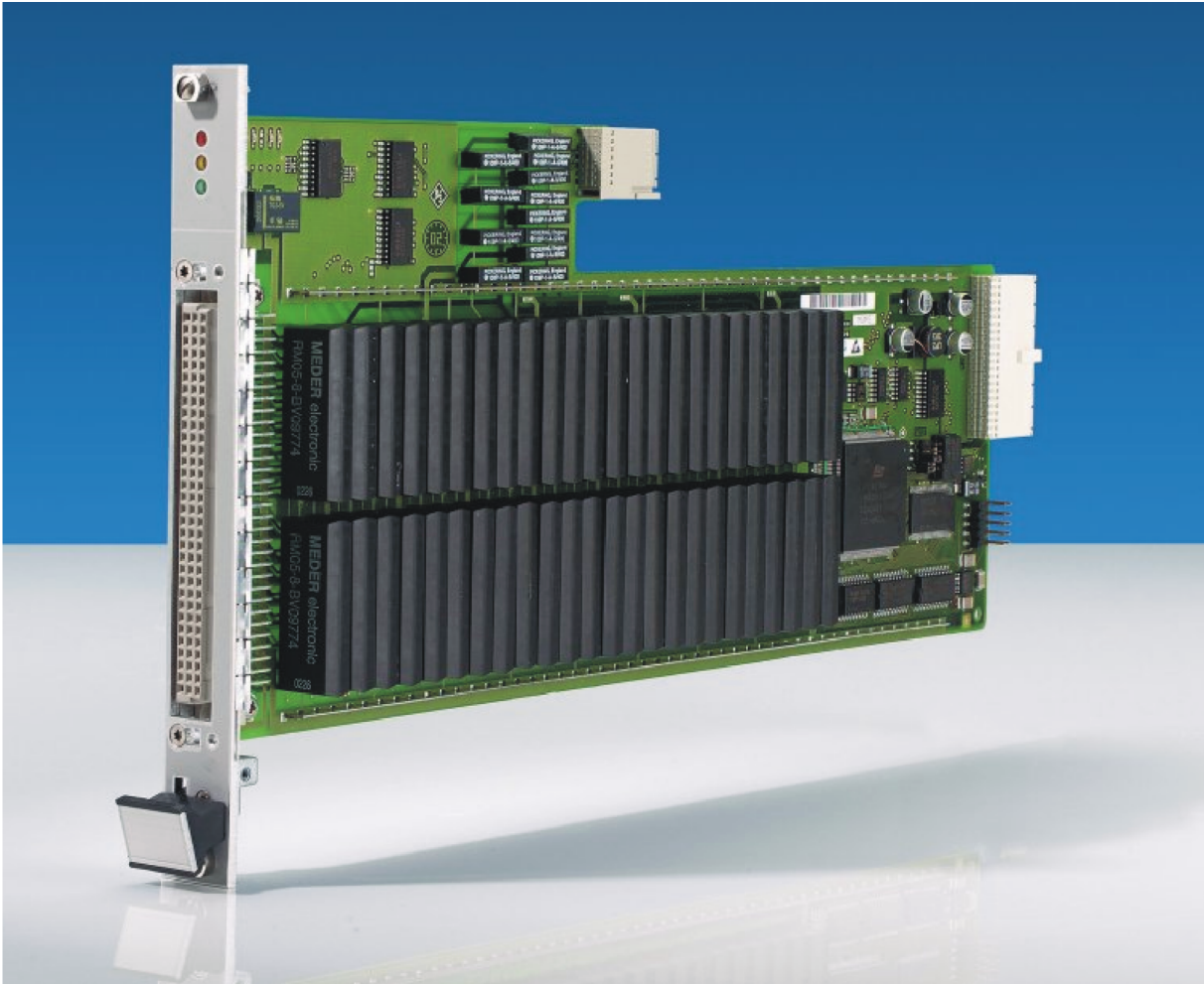

1153.5233.12 – 05

This manual describes the following R&S®TSVP module:

- R&S®TS-PMB

© 2016 Rohde & Schwarz GmbH & Co. KG

Mühlhofstr. 15, 81671 München, Germany

Phone: +49 89 41 29 - 0

Fax: +49 89 41 29 12 164

Email: info@rohde-schwarz.com

Internet: www.rohde-schwarz.com

Subject to change – Data without tolerance limits is not binding.

R&S® is a registered trademark of Rohde & Schwarz GmbH & Co. KG.

Trade names are trademarks of the owners.

The following abbreviations are used throughout this manual: R&S®TS-PMB is abbreviated as R&S TS-PMB.

Basic Safety Instructions

Always read through and comply with the following safety instructions!

All plants and locations of the Rohde & Schwarz group of companies make every effort to keep the safety standards of our products up to date and to offer our customers the highest possible degree of safety. Our products and the auxiliary equipment they require are designed, built and tested in accordance with the safety standards that apply in each case. Compliance with these standards is continuously monitored by our quality assurance system. The product described here has been designed, built and tested in accordance with the EC Certificate of Conformity and has left the manufacturer's plant in a condition fully complying with safety standards. To maintain this condition and to ensure safe operation, you must observe all instructions and warnings provided in this manual. If you have any questions regarding these safety instructions, the Rohde & Schwarz group of companies will be happy to answer them.

Furthermore, it is your responsibility to use the product in an appropriate manner. This product is designed for use solely in industrial and laboratory environments or, if expressly permitted, also in the field and must not be used in any way that may cause personal injury or property damage. You are responsible if the product is used for any purpose other than its designated purpose or in disregard of the manufacturer's instructions. The manufacturer shall assume no responsibility for such use of the product.

The product is used for its designated purpose if it is used in accordance with its product documentation and within its performance limits (see data sheet, documentation, the following safety instructions). Using the product requires technical skills and, in some cases, a basic knowledge of English. It is therefore essential that only skilled and specialized staff or thoroughly trained personnel with the required skills be allowed to use the product. If personal safety gear is required for using Rohde & Schwarz products, this will be indicated at the appropriate place in the product documentation. Keep the basic safety instructions and the product documentation in a safe place and pass them on to the subsequent users.

Observing the safety instructions will help prevent personal injury or damage of any kind caused by dangerous situations. Therefore, carefully read through and adhere to the following safety instructions before and when using the product. It is also absolutely essential to observe the additional safety instructions on personal safety, for example, that appear in relevant parts of the product documentation. In these safety instructions, the word "product" refers to all merchandise sold and distributed by the Rohde & Schwarz group of companies, including instruments, systems and all accessories. For product-specific information, see the data sheet and the product documentation.

Safety labels on products

The following safety labels are used on products to warn against risks and dangers.

| Symbol | Meaning | Symbol | Meaning |
|---|--|---|---------------------|
|  | Notice, general danger location Observe product documentation |  | ON/OFF Power |
|  | Caution when handling heavy equipment |  | Standby indication |
|  | Danger of electric shock |  | Direct current (DC) |

Basic Safety Instructions

| Symbol | Meaning | Symbol | Meaning |
|---|---|--|--|
|  | Caution ! Hot surface |  | Alternating current (AC) |
|  | Protective conductor terminal To identify any terminal which is intended for connection to an external conductor for protection against electric shock in case of a fault, or the terminal of a protective earth |  | Direct/alternating current (DC/AC) |
|  | Earth (Ground) |  | Class II Equipment to identify equipment meeting the safety requirements specified for Class II equipment (device protected by double or reinforced insulation) |
|  | Frame or chassis Ground terminal |  | EU labeling for batteries and accumulators For additional information, see section "Waste disposal/Environmental protection", item 1. |
|  | Be careful when handling electrostatic sensitive devices |  | EU labeling for separate collection of electrical and electronic devices For additional information, see section "Waste disposal/Environmental protection", item 2. |
|  | Warning! Laser radiation For additional information, see section "Operation", item 7. | | |

Signal words and their meaning

The following signal words are used in the product documentation in order to warn the reader about risks and dangers.



Indicates a hazardous situation which, if not avoided, will result in death or serious injury.



Indicates a hazardous situation which, if not avoided, could result in death or serious injury.



Indicates a hazardous situation which, if not avoided, could result in minor or moderate injury.



Indicates information considered important, but not hazard-related, e.g. messages relating to property damage.
In the product documentation, the word ATTENTION is used synonymously.

These signal words are in accordance with the standard definition for civil applications in the European Economic Area. Definitions that deviate from the standard definition may also exist in other economic areas or military applications. It is therefore essential to make sure that the signal words described here are always used only in connection with the related product documentation and the related product. The use of signal words in connection with unrelated products or documentation can result in misinterpretation and in personal injury or material damage.

Basic Safety Instructions

Operating states and operating positions

The product may be operated only under the operating conditions and in the positions specified by the manufacturer, without the product's ventilation being obstructed. If the manufacturer's specifications are not observed, this can result in electric shock, fire and/or serious personal injury or death. Applicable local or national safety regulations and rules for the prevention of accidents must be observed in all work performed.

1. Unless otherwise specified, the following requirements apply to Rohde & Schwarz products: predefined operating position is always with the housing floor facing down, IP protection 2X, use only indoors, max. operating altitude 2000 m above sea level, max. transport altitude 4500 m above sea level. A tolerance of $\pm 10\%$ shall apply to the nominal voltage and $\pm 5\%$ to the nominal frequency, overvoltage category 2, pollution degree 2.
2. Do not place the product on surfaces, vehicles, cabinets or tables that for reasons of weight or stability are unsuitable for this purpose. Always follow the manufacturer's installation instructions when installing the product and fastening it to objects or structures (e.g. walls and shelves). An installation that is not carried out as described in the product documentation could result in personal injury or even death.
3. Do not place the product on heat-generating devices such as radiators or fan heaters. The ambient temperature must not exceed the maximum temperature specified in the product documentation or in the data sheet. Product overheating can cause electric shock, fire and/or serious personal injury or even death.

Electrical safety

If the information on electrical safety is not observed either at all or to the extent necessary, electric shock, fire and/or serious personal injury or death may occur.

1. Prior to switching on the product, always ensure that the nominal voltage setting on the product matches the nominal voltage of the mains-supply network. If a different voltage is to be set, the power fuse of the product may have to be changed accordingly.
2. In the case of products of safety class I with movable power cord and connector, operation is permitted only on sockets with a protective conductor contact and protective conductor.
3. Intentionally breaking the protective conductor either in the feed line or in the product itself is not permitted. Doing so can result in the danger of an electric shock from the product. If extension cords or connector strips are implemented, they must be checked on a regular basis to ensure that they are safe to use.
4. If there is no power switch for disconnecting the product from the mains, or if the power switch is not suitable for this purpose, use the plug of the connecting cable to disconnect the product from the mains. In such cases, always ensure that the power plug is easily reachable and accessible at all times. For example, if the power plug is the disconnecting device, the length of the connecting cable must not exceed 3 m. Functional or electronic switches are not suitable for providing disconnection from the AC supply network. If products without power switches are integrated into racks or systems, the disconnecting device must be provided at the system level.
5. Never use the product if the power cable is damaged. Check the power cables on a regular basis to ensure that they are in proper operating condition. By taking appropriate safety measures and carefully laying the power cable, ensure that the cable cannot be damaged and that no one can be hurt by, for example, tripping over the cable or suffering an electric shock.

Basic Safety Instructions

6. The product may be operated only from TN/TT supply networks fuse-protected with max. 16 A (higher fuse only after consulting with the Rohde & Schwarz group of companies).
7. Do not insert the plug into sockets that are dusty or dirty. Insert the plug firmly and all the way into the socket provided for this purpose. Otherwise, sparks that result in fire and/or injuries may occur.
8. Do not overload any sockets, extension cords or connector strips; doing so can cause fire or electric shocks.
9. For measurements in circuits with voltages $V_{rms} > 30$ V, suitable measures (e.g. appropriate measuring equipment, fuse protection, current limiting, electrical separation, insulation) should be taken to avoid any hazards.
10. Ensure that the connections with information technology equipment, e.g. PCs or other industrial computers, comply with the IEC 60950-1 / EN 60950-1 or IEC 61010-1 / EN 61010-1 standards that apply in each case.
11. Unless expressly permitted, never remove the cover or any part of the housing while the product is in operation. Doing so will expose circuits and components and can lead to injuries, fire or damage to the product.
12. If a product is to be permanently installed, the connection between the protective conductor terminal on site and the product's protective conductor must be made first before any other connection is made. The product may be installed and connected only by a licensed electrician.
13. For permanently installed equipment without built-in fuses, circuit breakers or similar protective devices, the supply circuit must be fuse-protected in such a way that anyone who has access to the product, as well as the product itself, is adequately protected from injury or damage.
14. Use suitable overvoltage protection to ensure that no overvoltage (such as that caused by a bolt of lightning) can reach the product. Otherwise, the person operating the product will be exposed to the danger of an electric shock.
15. Any object that is not designed to be placed in the openings of the housing must not be used for this purpose. Doing so can cause short circuits inside the product and/or electric shocks, fire or injuries.
16. Unless specified otherwise, products are not liquid-proof (see also section "Operating states and operating positions", item 1). Therefore, the equipment must be protected against penetration by liquids. If the necessary precautions are not taken, the user may suffer electric shock or the product itself may be damaged, which can also lead to personal injury.
17. Never use the product under conditions in which condensation has formed or can form in or on the product, e.g. if the product has been moved from a cold to a warm environment. Penetration by water increases the risk of electric shock.
18. Prior to cleaning the product, disconnect it completely from the power supply (e.g. AC supply network or battery). Use a soft, non-linting cloth to clean the product. Never use chemical cleaning agents such as alcohol, acetone or diluents for cellulose lacquers.

Operation

1. Operating the products requires special training and intense concentration. Make sure that persons who use the products are physically, mentally and emotionally fit enough to do so; otherwise, injuries or material damage may occur. It is the responsibility of the employer/operator to select suitable personnel for operating the products.

Basic Safety Instructions

2. Before you move or transport the product, read and observe the section titled "Transport".
3. As with all industrially manufactured goods, the use of substances that induce an allergic reaction (allergens) such as nickel cannot be generally excluded. If you develop an allergic reaction (such as a skin rash, frequent sneezing, red eyes or respiratory difficulties) when using a Rohde & Schwarz product, consult a physician immediately to determine the cause and to prevent health problems or stress.
4. Before you start processing the product mechanically and/or thermally, or before you take it apart, be sure to read and pay special attention to the section titled "Waste disposal/Environmental protection", item 1.
5. Depending on the function, certain products such as RF radio equipment can produce an elevated level of electromagnetic radiation. Considering that unborn babies require increased protection, pregnant women must be protected by appropriate measures. Persons with pacemakers may also be exposed to risks from electromagnetic radiation. The employer/operator must evaluate workplaces where there is a special risk of exposure to radiation and, if necessary, take measures to avert the potential danger.
6. Should a fire occur, the product may release hazardous substances (gases, fluids, etc.) that can cause health problems. Therefore, suitable measures must be taken, e.g. protective masks and protective clothing must be worn.
7. Laser products are given warning labels that are standardized according to their laser class. Lasers can cause biological harm due to the properties of their radiation and due to their extremely concentrated electromagnetic power. If a laser product (e.g. a CD/DVD drive) is integrated into a Rohde & Schwarz product, absolutely no other settings or functions may be used as described in the product documentation. The objective is to prevent personal injury (e.g. due to laser beams).
8. EMC classes (in line with EN 55011/CISPR 11, and analogously with EN 55022/CISPR 22, EN 55032/CISPR 32)
 - Class A equipment:
Equipment suitable for use in all environments except residential environments and environments that are directly connected to a low-voltage supply network that supplies residential buildings
Note: Class A equipment is intended for use in an industrial environment. This equipment may cause radio disturbances in residential environments, due to possible conducted as well as radiated disturbances. In this case, the operator may be required to take appropriate measures to eliminate these disturbances.
 - Class B equipment:
Equipment suitable for use in residential environments and environments that are directly connected to a low-voltage supply network that supplies residential buildings

Repair and service

1. The product may be opened only by authorized, specially trained personnel. Before any work is performed on the product or before the product is opened, it must be disconnected from the AC supply network. Otherwise, personnel will be exposed to the risk of an electric shock.

Basic Safety Instructions

- Adjustments, replacement of parts, maintenance and repair may be performed only by electrical experts authorized by Rohde & Schwarz. Only original parts may be used for replacing parts relevant to safety (e.g. power switches, power transformers, fuses). A safety test must always be performed after parts relevant to safety have been replaced (visual inspection, protective conductor test, insulation resistance measurement, leakage current measurement, functional test). This helps ensure the continued safety of the product.

Batteries and rechargeable batteries/cells

If the information regarding batteries and rechargeable batteries/cells is not observed either at all or to the extent necessary, product users may be exposed to the risk of explosions, fire and/or serious personal injury, and, in some cases, death. Batteries and rechargeable batteries with alkaline electrolytes (e.g. lithium cells) must be handled in accordance with the EN 62133 standard.

- Cells must not be taken apart or crushed.
- Cells or batteries must not be exposed to heat or fire. Storage in direct sunlight must be avoided. Keep cells and batteries clean and dry. Clean soiled connectors using a dry, clean cloth.
- Cells or batteries must not be short-circuited. Cells or batteries must not be stored in a box or in a drawer where they can short-circuit each other, or where they can be short-circuited by other conductive materials. Cells and batteries must not be removed from their original packaging until they are ready to be used.
- Cells and batteries must not be exposed to any mechanical shocks that are stronger than permitted.
- If a cell develops a leak, the fluid must not be allowed to come into contact with the skin or eyes. If contact occurs, wash the affected area with plenty of water and seek medical aid.
- Improperly replacing or charging cells or batteries that contain alkaline electrolytes (e.g. lithium cells) can cause explosions. Replace cells or batteries only with the matching Rohde & Schwarz type (see parts list) in order to ensure the safety of the product.
- Cells and batteries must be recycled and kept separate from residual waste. Rechargeable batteries and normal batteries that contain lead, mercury or cadmium are hazardous waste. Observe the national regulations regarding waste disposal and recycling.

Transport

- The product may be very heavy. Therefore, the product must be handled with care. In some cases, the user may require a suitable means of lifting or moving the product (e.g. with a lift-truck) to avoid back or other physical injuries.
- Handles on the products are designed exclusively to enable personnel to transport the product. It is therefore not permissible to use handles to fasten the product to or on transport equipment such as cranes, fork lifts, wagons, etc. The user is responsible for securely fastening the products to or on the means of transport or lifting. Observe the safety regulations of the manufacturer of the means of transport or lifting. Noncompliance can result in personal injury or material damage.
- If you use the product in a vehicle, it is the sole responsibility of the driver to drive the vehicle safely and properly. The manufacturer assumes no responsibility for accidents or collisions. Never use the product in a moving vehicle if doing so could distract the driver of the vehicle. Adequately secure the product in the vehicle to prevent injuries or other damage in the event of an accident.

Instrucciones de seguridad elementales

Waste disposal/Environmental protection

1. Specially marked equipment has a battery or accumulator that must not be disposed of with unsorted municipal waste, but must be collected separately. It may only be disposed of at a suitable collection point or via a Rohde & Schwarz customer service center.
2. Waste electrical and electronic equipment must not be disposed of with unsorted municipal waste, but must be collected separately.
Rohde & Schwarz GmbH & Co. KG has developed a disposal concept and takes full responsibility for take-back obligations and disposal obligations for manufacturers within the EU. Contact your Rohde & Schwarz customer service center for environmentally responsible disposal of the product.
3. If products or their components are mechanically and/or thermally processed in a manner that goes beyond their intended use, hazardous substances (heavy-metal dust such as lead, beryllium, nickel) may be released. For this reason, the product may only be disassembled by specially trained personnel. Improper disassembly may be hazardous to your health. National waste disposal regulations must be observed.
4. If handling the product releases hazardous substances or fuels that must be disposed of in a special way, e.g. coolants or engine oils that must be replenished regularly, the safety instructions of the manufacturer of the hazardous substances or fuels and the applicable regional waste disposal regulations must be observed. Also observe the relevant safety instructions in the product documentation. The improper disposal of hazardous substances or fuels can cause health problems and lead to environmental damage.

For additional information about environmental protection, visit the Rohde & Schwarz website.

Instrucciones de seguridad elementales

¡Es imprescindible leer y cumplir las siguientes instrucciones e informaciones de seguridad!

El principio del grupo de empresas Rohde & Schwarz consiste en tener nuestros productos siempre al día con los estándares de seguridad y de ofrecer a nuestros clientes el máximo grado de seguridad. Nuestros productos y todos los equipos adicionales son siempre fabricados y examinados según las normas de seguridad vigentes. Nuestro sistema de garantía de calidad controla constantemente que sean cumplidas estas normas. El presente producto ha sido fabricado y examinado según el certificado de conformidad de la UE y ha salido de nuestra planta en estado impecable según los estándares técnicos de seguridad. Para poder preservar este estado y garantizar un funcionamiento libre de peligros, el usuario deberá atenerse a todas las indicaciones, informaciones de seguridad y notas de alerta. El grupo de empresas Rohde & Schwarz está siempre a su disposición en caso de que tengan preguntas referentes a estas informaciones de seguridad.

Además queda en la responsabilidad del usuario utilizar el producto en la forma debida. Este producto está destinado exclusivamente al uso en la industria y el laboratorio o, si ha sido expresamente autorizado, para aplicaciones de campo y de ninguna manera deberá ser utilizado de modo que alguna persona/cosa pueda sufrir daño. El uso del producto fuera de sus fines definidos o sin tener en cuenta las instrucciones del fabricante queda en la responsabilidad del usuario. El fabricante no se hace en ninguna forma responsable de consecuencias a causa del mal uso del producto.

Instrucciones de seguridad elementales

Se parte del uso correcto del producto para los fines definidos si el producto es utilizado conforme a las indicaciones de la correspondiente documentación del producto y dentro del margen de rendimiento definido (ver hoja de datos, documentación, informaciones de seguridad que siguen). El uso del producto hace necesarios conocimientos técnicos y ciertos conocimientos del idioma inglés. Por eso se debe tener en cuenta que el producto solo pueda ser operado por personal especializado o personas instruidas en profundidad con las capacidades correspondientes. Si fuera necesaria indumentaria de seguridad para el uso de productos de Rohde & Schwarz, encontraría la información debida en la documentación del producto en el capítulo correspondiente. Guarde bien las informaciones de seguridad elementales, así como la documentación del producto, y entréguelas a usuarios posteriores.

Tener en cuenta las informaciones de seguridad sirve para evitar en lo posible lesiones o daños por peligros de toda clase. Por eso es imprescindible leer detalladamente y comprender por completo las siguientes informaciones de seguridad antes de usar el producto, y respetarlas durante el uso del producto. Deberán tenerse en cuenta todas las demás informaciones de seguridad, como p. ej. las referentes a la protección de personas, que encontrarán en el capítulo correspondiente de la documentación del producto y que también son de obligado cumplimiento. En las presentes informaciones de seguridad se recogen todos los objetos que distribuye el grupo de empresas Rohde & Schwarz bajo la denominación de "producto", entre ellos también aparatos, instalaciones así como toda clase de accesorios. Los datos específicos del producto figuran en la hoja de datos y en la documentación del producto.

Señalización de seguridad de los productos

Las siguientes señales de seguridad se utilizan en los productos para advertir sobre riesgos y peligros.

| Símbolo | Significado | Símbolo | Significado |
|---|---|---|---|
|  | Aviso: punto de peligro general Observar la documentación del producto |  | Tensión de alimentación de PUESTA EN MARCHA / PARADA |
|  | Atención en el manejo de dispositivos de peso elevado |  | Indicación de estado de espera (standby) |
|  | Peligro de choque eléctrico |  | Corriente continua (DC) |
|  | Advertencia: superficie caliente |  | Corriente alterna (AC) |
|  | Conexión a conductor de protección |  | Corriente continua / Corriente alterna (DC/AC) |
|  | Conexión a tierra |  | El aparato está protegido en su totalidad por un aislamiento doble (reforzado) |
|  | Conexión a masa |  | Distintivo de la UE para baterías y acumuladores Más información en la sección "Eliminación/protección del medio ambiente", punto 1. |

Instrucciones de seguridad elementales

| Símbolo | Significado | Símbolo | Significado |
|---|---|---|---|
|  | Aviso: Cuidado en el manejo de dispositivos sensibles a la electrostática (ESD) |  | Distintivo de la UE para la eliminación por separado de dispositivos eléctricos y electrónicos Más información en la sección "Eliminación/protección del medio ambiente", punto 2. |
|  | Advertencia: rayo láser Más información en la sección "Funcionamiento", punto 7. | | |

Palabras de señal y su significado

En la documentación del producto se utilizan las siguientes palabras de señal con el fin de advertir contra riesgos y peligros.



Indica una situación de peligro que, si no se evita, causa lesiones graves o incluso la muerte.



Indica una situación de peligro que, si no se evita, puede causar lesiones graves o incluso la muerte.



Indica una situación de peligro que, si no se evita, puede causar lesiones leves o moderadas.



Indica información que se considera importante, pero no en relación con situaciones de peligro; p. ej., avisos sobre posibles daños materiales.

En la documentación del producto se emplea de forma sinónima el término CUIDADO.

Las palabras de señal corresponden a la definición habitual para aplicaciones civiles en el área económica europea. Pueden existir definiciones diferentes a esta definición en otras áreas económicas o en aplicaciones militares. Por eso se deberá tener en cuenta que las palabras de señal aquí descritas sean utilizadas siempre solamente en combinación con la correspondiente documentación del producto y solamente en combinación con el producto correspondiente. La utilización de las palabras de señal en combinación con productos o documentaciones que no les correspondan puede llevar a interpretaciones equivocadas y tener por consecuencia daños en personas u objetos.

Estados operativos y posiciones de funcionamiento

El producto solamente debe ser utilizado según lo indicado por el fabricante respecto a los estados operativos y posiciones de funcionamiento sin que se obstruya la ventilación. Si no se siguen las indicaciones del fabricante, pueden producirse choques eléctricos, incendios y/o lesiones graves con posible consecuencia de muerte. En todos los trabajos deberán ser tenidas en cuenta las normas nacionales y locales de seguridad del trabajo y de prevención de accidentes.

Instrucciones de seguridad elementales

1. Si no se convino de otra manera, es para los productos Rohde & Schwarz válido lo que sigue: como posición de funcionamiento se define por principio la posición con el suelo de la caja para abajo, modo de protección IP 2X, uso solamente en estancias interiores, utilización hasta 2000 m sobre el nivel del mar, transporte hasta 4500 m sobre el nivel del mar. Se aplicará una tolerancia de $\pm 10\%$ sobre el voltaje nominal y de $\pm 5\%$ sobre la frecuencia nominal. Categoría de sobrecarga eléctrica 2, índice de suciedad 2.
2. No sitúe el producto encima de superficies, vehículos, estantes o mesas, que por sus características de peso o de estabilidad no sean aptos para él. Siga siempre las instrucciones de instalación del fabricante cuando instale y asegure el producto en objetos o estructuras (p. ej. paredes y estantes). Si se realiza la instalación de modo distinto al indicado en la documentación del producto, se pueden causar lesiones o, en determinadas circunstancias, incluso la muerte.
3. No ponga el producto sobre aparatos que generen calor (p. ej. radiadores o calefactores). La temperatura ambiente no debe superar la temperatura máxima especificada en la documentación del producto o en la hoja de datos. En caso de sobrecalentamiento del producto, pueden producirse choques eléctricos, incendios y/o lesiones graves con posible consecuencia de muerte.

Seguridad eléctrica

Si no se siguen (o se siguen de modo insuficiente) las indicaciones del fabricante en cuanto a seguridad eléctrica, pueden producirse choques eléctricos, incendios y/o lesiones graves con posible consecuencia de muerte.

1. Antes de la puesta en marcha del producto se deberá comprobar siempre que la tensión preseleccionada en el producto coincida con la de la red de alimentación eléctrica. Si es necesario modificar el ajuste de tensión, también se deberán cambiar en caso dado los fusibles correspondientes del producto.
2. Los productos de la clase de protección I con alimentación móvil y enchufe individual solamente podrán enchufarse a tomas de corriente con contacto de seguridad y con conductor de protección conectado.
3. Queda prohibida la interrupción intencionada del conductor de protección, tanto en la toma de corriente como en el mismo producto. La interrupción puede tener como consecuencia el riesgo de que el producto sea fuente de choques eléctricos. Si se utilizan cables alargadores o regletas de enchufe, deberá garantizarse la realización de un examen regular de los mismos en cuanto a su estado técnico de seguridad.
4. Si el producto no está equipado con un interruptor para desconectarlo de la red, o bien si el interruptor existente no resulta apropiado para la desconexión de la red, el enchufe del cable de conexión se deberá considerar como un dispositivo de desconexión. El dispositivo de desconexión se debe poder alcanzar fácilmente y debe estar siempre bien accesible. Si, p. ej., el enchufe de conexión a la red es el dispositivo de desconexión, la longitud del cable de conexión no debe superar 3 m). Los interruptores selectores o electrónicos no son aptos para el corte de la red eléctrica. Si se integran productos sin interruptor en bastidores o instalaciones, se deberá colocar el interruptor en el nivel de la instalación.
5. No utilice nunca el producto si está dañado el cable de conexión a red. Compruebe regularmente el correcto estado de los cables de conexión a red. Asegúrese, mediante las medidas de protección y de instalación adecuadas, de que el cable de conexión a red no pueda ser dañado o de que nadie pueda ser dañado por él, p. ej. al tropezar o por un choque eléctrico.

Instrucciones de seguridad elementales

6. Solamente está permitido el funcionamiento en redes de alimentación TN/TT aseguradas con fusibles de 16 A como máximo (utilización de fusibles de mayor amperaje solo previa consulta con el grupo de empresas Rohde & Schwarz).
7. Nunca conecte el enchufe en tomas de corriente sucias o llenas de polvo. Introduzca el enchufe por completo y fuertemente en la toma de corriente. La no observación de estas medidas puede provocar chispas, fuego y/o lesiones.
8. No sobrecargue las tomas de corriente, los cables alargadores o las regletas de enchufe ya que esto podría causar fuego o choques eléctricos.
9. En las mediciones en circuitos de corriente con una tensión $U_{\text{eff}} > 30 \text{ V}$ se deberán tomar las medidas apropiadas para impedir cualquier peligro (p. ej. medios de medición adecuados, seguros, limitación de tensión, corte protector, aislamiento etc.).
10. Para la conexión con dispositivos informáticos como un PC o un ordenador industrial, debe comprobarse que éstos cumplan los estándares IEC60950-1/EN60950-1 o IEC61010-1/EN 61010-1 válidos en cada caso.
11. A menos que esté permitido expresamente, no retire nunca la tapa ni componentes de la carcasa mientras el producto esté en servicio. Esto pone a descubierto los cables y componentes eléctricos y puede causar lesiones, fuego o daños en el producto.
12. Si un producto se instala en un lugar fijo, se deberá primero conectar el conductor de protección fijo con el conductor de protección del producto antes de hacer cualquier otra conexión. La instalación y la conexión deberán ser efectuadas por un electricista especializado.
13. En el caso de dispositivos fijos que no estén provistos de fusibles, interruptor automático ni otros mecanismos de seguridad similares, el circuito de alimentación debe estar protegido de modo que todas las personas que puedan acceder al producto, así como el producto mismo, estén a salvo de posibles daños.
14. Todo producto debe estar protegido contra sobretensión (debida p. ej. a una caída del rayo) mediante los correspondientes sistemas de protección. Si no, el personal que lo utilice quedará expuesto al peligro de choque eléctrico.
15. No debe introducirse en los orificios de la caja del aparato ningún objeto que no esté destinado a ello. Esto puede producir cortocircuitos en el producto y/o puede causar choques eléctricos, fuego o lesiones.
16. Salvo indicación contraria, los productos no están impermeabilizados (ver también el capítulo "Estados operativos y posiciones de funcionamiento", punto 1). Por eso es necesario tomar las medidas necesarias para evitar la entrada de líquidos. En caso contrario, existe peligro de choque eléctrico para el usuario o de daños en el producto, que también pueden redundar en peligro para las personas.
17. No utilice el producto en condiciones en las que pueda producirse o ya se hayan producido condensaciones sobre el producto o en el interior de éste, como p. ej. al desplazarlo de un lugar frío a otro caliente. La entrada de agua aumenta el riesgo de choque eléctrico.
18. Antes de la limpieza, desconecte por completo el producto de la alimentación de tensión (p. ej. red de alimentación o batería). Realice la limpieza de los aparatos con un paño suave, que no se deshilache. No utilice bajo ningún concepto productos de limpieza químicos como alcohol, acetona o diluyentes para lacas nitrocelulósicas.

Instrucciones de seguridad elementales

Funcionamiento

1. El uso del producto requiere instrucciones especiales y una alta concentración durante el manejo. Debe asegurarse que las personas que manejen el producto estén a la altura de los requerimientos necesarios en cuanto a aptitudes físicas, psíquicas y emocionales, ya que de otra manera no se pueden excluir lesiones o daños de objetos. El empresario u operador es responsable de seleccionar el personal usuario apto para el manejo del producto.
2. Antes de desplazar o transportar el producto, lea y tenga en cuenta el capítulo "Transporte".
3. Como con todo producto de fabricación industrial no puede quedar excluida en general la posibilidad de que se produzcan alergias provocadas por algunos materiales empleados —los llamados alérgenos (p. ej. el níquel)—. Si durante el manejo de productos Rohde & Schwarz se producen reacciones alérgicas, como p. ej. irritaciones cutáneas, estornudos continuos, enrojecimiento de la conjuntiva o dificultades respiratorias, debe avisarse inmediatamente a un médico para investigar las causas y evitar cualquier molestia o daño a la salud.
4. Antes de la manipulación mecánica y/o térmica o el desmontaje del producto, debe tenerse en cuenta imprescindiblemente el capítulo "Eliminación/protección del medio ambiente", punto 1.
5. Ciertos productos, como p. ej. las instalaciones de radiocomunicación RF, pueden a causa de su función natural, emitir una radiación electromagnética aumentada. Deben tomarse todas las medidas necesarias para la protección de las mujeres embarazadas. También las personas con marcapasos pueden correr peligro a causa de la radiación electromagnética. El empresario/operador tiene la obligación de evaluar y señalar las áreas de trabajo en las que exista un riesgo elevado de exposición a radiaciones.
6. Tenga en cuenta que en caso de incendio pueden desprenderse del producto sustancias tóxicas (gases, líquidos etc.) que pueden generar daños a la salud. Por eso, en caso de incendio deben usarse medidas adecuadas, como p. ej. máscaras antigás e indumentaria de protección.
7. Los productos con láser están provistos de indicaciones de advertencia normalizadas en función de la clase de láser del que se trate. Los rayos láser pueden provocar daños de tipo biológico a causa de las propiedades de su radiación y debido a su concentración extrema de potencia electromagnética. En caso de que un producto Rohde & Schwarz contenga un producto láser (p. ej. un lector de CD/DVD), no debe usarse ninguna otra configuración o función aparte de las descritas en la documentación del producto, a fin de evitar lesiones (p. ej. debidas a irradiación láser).
8. Clases de compatibilidad electromagnética (conforme a EN 55011 / CISPR 11; y en analogía con EN 55022 / CISPR 22, EN 55032 / CISPR 32)
 - Aparato de clase A:
Aparato adecuado para su uso en todos los entornos excepto en los residenciales y en aquellos conectados directamente a una red de distribución de baja tensión que suministra corriente a edificios residenciales.
Nota: Los aparatos de clase A están destinados al uso en entornos industriales. Estos aparatos pueden causar perturbaciones radioeléctricas en entornos residenciales debido a posibles perturbaciones guiadas o radiadas. En este caso, se le podrá solicitar al operador que tome las medidas adecuadas para eliminar estas perturbaciones.
 - Aparato de clase B:
Aparato adecuado para su uso en entornos residenciales, así como en aquellos conectados directamente a una red de distribución de baja tensión que suministra corriente a edificios residenciales.

Instrucciones de seguridad elementales

Reparación y mantenimiento

1. El producto solamente debe ser abierto por personal especializado con autorización para ello. Antes de manipular el producto o abrirlo, es obligatorio desconectarlo de la tensión de alimentación, para evitar toda posibilidad de choque eléctrico.
2. El ajuste, el cambio de partes, el mantenimiento y la reparación deberán ser efectuadas solamente por electricistas autorizados por Rohde & Schwarz. Si se reponen partes con importancia para los aspectos de seguridad (p. ej. el enchufe, los transformadores o los fusibles), solamente podrán ser sustituidos por partes originales. Después de cada cambio de partes relevantes para la seguridad deberá realizarse un control de seguridad (control a primera vista, control del conductor de protección, medición de resistencia de aislamiento, medición de la corriente de fuga, control de funcionamiento). Con esto queda garantizada la seguridad del producto.

Baterías y acumuladores o celdas

Si no se siguen (o se siguen de modo insuficiente) las indicaciones en cuanto a las baterías y acumuladores o celdas, pueden producirse explosiones, incendios y/o lesiones graves con posible consecuencia de muerte. El manejo de baterías y acumuladores con electrolitos alcalinos (p. ej. celdas de litio) debe seguir el estándar EN 62133.

1. No deben desmontarse, abrirse ni triturarse las celdas.
2. Las celdas o baterías no deben someterse a calor ni fuego. Debe evitarse el almacenamiento a la luz directa del sol. Las celdas y baterías deben mantenerse limpias y secas. Limpiar las conexiones sucias con un paño seco y limpio.
3. Las celdas o baterías no deben cortocircuitarse. Es peligroso almacenar las celdas o baterías en estuches o cajones en cuyo interior puedan cortocircuitarse por contacto recíproco o por contacto con otros materiales conductores. No deben extraerse las celdas o baterías de sus embalajes originales hasta el momento en que vayan a utilizarse.
4. Las celdas o baterías no deben someterse a impactos mecánicos fuertes indebidos.
5. En caso de falta de estanqueidad de una celda, el líquido vertido no debe entrar en contacto con la piel ni los ojos. Si se produce contacto, lavar con agua abundante la zona afectada y avisar a un médico.
6. En caso de cambio o recarga inadecuados, las celdas o baterías que contienen electrolitos alcalinos (p. ej. las celdas de litio) pueden explotar. Para garantizar la seguridad del producto, las celdas o baterías solo deben ser sustituidas por el tipo Rohde & Schwarz correspondiente (ver lista de recambios).
7. Las baterías y celdas deben reciclarse y no deben tirarse a la basura doméstica. Las baterías o acumuladores que contienen plomo, mercurio o cadmio deben tratarse como residuos especiales. Respete en esta relación las normas nacionales de eliminación y reciclaje.

Transporte

1. El producto puede tener un peso elevado. Por eso es necesario desplazarlo o transportarlo con precaución y, si es necesario, usando un sistema de elevación adecuado (p. ej. una carretilla elevadora), a fin de evitar lesiones en la espalda u otros daños personales.

Instrucciones de seguridad elementales

2. Las asas instaladas en los productos sirven solamente de ayuda para el transporte del producto por personas. Por eso no está permitido utilizar las asas para la sujeción en o sobre medios de transporte como p. ej. grúas, carretillas elevadoras de horquilla, carros etc. Es responsabilidad suya fijar los productos de manera segura a los medios de transporte o elevación. Para evitar daños personales o daños en el producto, siga las instrucciones de seguridad del fabricante del medio de transporte o elevación utilizado.
3. Si se utiliza el producto dentro de un vehículo, recae de manera exclusiva en el conductor la responsabilidad de conducir el vehículo de manera segura y adecuada. El fabricante no asumirá ninguna responsabilidad por accidentes o colisiones. No utilice nunca el producto dentro de un vehículo en movimiento si esto pudiera distraer al conductor. Asegure el producto dentro del vehículo debidamente para evitar, en caso de un accidente, lesiones u otra clase de daños.

Eliminación/protección del medio ambiente

1. Los dispositivos marcados contienen una batería o un acumulador que no se debe desechar con los residuos domésticos sin clasificar, sino que debe ser recogido por separado. La eliminación se debe efectuar exclusivamente a través de un punto de recogida apropiado o del servicio de atención al cliente de Rohde & Schwarz.
2. Los dispositivos eléctricos usados no se deben desechar con los residuos domésticos sin clasificar, sino que deben ser recogidos por separado.
Rohde & Schwarz GmbH & Co.KG ha elaborado un concepto de eliminación de residuos y asume plenamente los deberes de recogida y eliminación para los fabricantes dentro de la UE. Para desechar el producto de manera respetuosa con el medio ambiente, dirijase a su servicio de atención al cliente de Rohde & Schwarz.
3. Si se trabaja de manera mecánica y/o térmica cualquier producto o componente más allá del funcionamiento previsto, pueden liberarse sustancias peligrosas (polvos con contenido de metales pesados como p. ej. plomo, berilio o níquel). Por eso el producto solo debe ser desmontado por personal especializado con formación adecuada. Un desmontaje inadecuado puede ocasionar daños para la salud. Se deben tener en cuenta las directivas nacionales referentes a la eliminación de residuos.
4. En caso de que durante el trato del producto se formen sustancias peligrosas o combustibles que deban tratarse como residuos especiales (p. ej. refrigerantes o aceites de motor con intervalos de cambio definidos), deben tenerse en cuenta las indicaciones de seguridad del fabricante de dichas sustancias y las normas regionales de eliminación de residuos. Tenga en cuenta también en caso necesario las indicaciones de seguridad especiales contenidas en la documentación del producto. La eliminación incorrecta de sustancias peligrosas o combustibles puede causar daños a la salud o daños al medio ambiente.

Se puede encontrar más información sobre la protección del medio ambiente en la página web de Rohde & Schwarz.

Quality management and environmental management

Certified Quality System
ISO 9001

Certified Environmental System
ISO 14001

Sehr geehrter Kunde,

Sie haben sich für den Kauf eines Rohde&Schwarz Produktes entschieden. Sie erhalten damit ein nach modernsten Fertigungsmethoden hergestelltes Produkt. Es wurde nach den Regeln unserer Qualitäts- und Umweltmanagementsysteme entwickelt, gefertigt und geprüft. Rohde&Schwarz ist unter anderem nach den Managementsystemen ISO9001 und ISO 14001 zertifiziert.

Der Umwelt verpflichtet

- Energie-effiziente, RoHS-konforme Produkte
- Kontinuierliche Weiterentwicklung nachhaltiger Umweltkonzepte
- ISO 14001-zertifiziertes Umweltmanagementsystem

Dear customer,

You have decided to buy a Rohde&Schwarz product. This product has been manufactured using the most advanced methods. It was developed, manufactured and tested in compliance with our quality management and environmental management systems. Rohde&Schwarz has been certified, for example, according to the ISO9001 and ISO 14001 management systems.

Environmental commitment

- Energy-efficient products
- Continuous improvement in environmental sustainability
- ISO 14001-certified environmental management system

Cher client,

Vous avez choisi d'acheter un produit Rohde&Schwarz. Vous disposez donc d'un produit fabriqué d'après les méthodes les plus avancées. Le développement, la fabrication et les tests de ce produit ont été effectués selon nos systèmes de management de qualité et de management environnemental. La société Rohde&Schwarz a été homologuée, entre autres, conformément aux systèmes de management ISO9001 et ISO 14001.

Engagement écologique

- Produits à efficience énergétique
- Amélioration continue de la durabilité environnementale
- Système de management environnemental certifié selon ISO 14001



Customer Support

Technical support – where and when you need it

For quick, expert help with any Rohde & Schwarz equipment, contact one of our Customer Support Centers. A team of highly qualified engineers provides telephone support and will work with you to find a solution to your query on any aspect of the operation, programming or applications of Rohde & Schwarz equipment.

Up-to-date information and upgrades

To keep your instrument up-to-date and to be informed about new application notes related to your instrument, please send an e-mail to the Customer Support Center stating your instrument and your wish. We will take care that you will get the right information.

Europe, Africa, Middle East

Phone +49 89 4129 12345
customersupport@rohde-schwarz.com

North America

Phone 1-888-TEST-RSA (1-888-837-8772)
customer.support@rsa.rohde-schwarz.com

Latin America

Phone +1-410-910-7988
customersupport.la@rohde-schwarz.com

Asia/Pacific

Phone +65 65 13 04 88
customersupport.asia@rohde-schwarz.com

China

Phone +86-800-810-8228 /
+86-400-650-5896
customersupport.china@rohde-schwarz.com



1 Usage

1.1 General

The ROHDE & SCHWARZ Matrix Module B R&S TS-PMB allows the universal inter-connection of test points and measuring instruments. This can be done locally or using the analog bus. The R&S TS-PMB can be used in the CompactTSVP and the PowerTSVP (TSVP = Test System Versatile Platform). Typical product test applications are in the fields of communications, automotive electronics and general industrial electronics, especially for analog In-Circuit Testing with a large number of channels.

The R&S TS-PMB is plugged into the front part of the TSVP chassis.

The front connector ends flush with the front panel of the TSVP chassis and is used for contacting the UUTs. An adapter frame can also be used if necessary.

At the rear, the R&S TS-PMB is connected with connector X20 to the cPCI backplane when used in the CompactTSVP or to the control backplane when used in the PowerTSVP. Connector X30 is used to connect the R&S TS-PMB to the analog bus backplane. This connector can be used to make connections with other plug-in modules (e.g. measuring modules) or external instruments.

1.2 Characteristics

Table 1-1: Characteristics R&S TS-PMB

| Characteristics R&S TS-PMB |
|--|
| Access to the analog bus (8-wire) |
| Full matrix with 4 buses with 90 pins |
| Full matrix with 8 buses with 45 pins |
| 3 Instrument ports |
| Parallel test with two 4-wire systems |
| In-Circuit Test wiring for 6-wire measurements |
| Connection of control signals in the Powertest together with the TS-PSM1 plug-in module. |
| Self-test capability |

2 View

Figure 2-1 shows a view of the R&S TS-PMB .



Figure 2-1: View of the R&S TS-PMB

The cPCI connector X1 is also fitted starting with Version V3.x.

3 Block Diagram

Figure 3-1 shows the block diagram of the R&S TS-PMB. A simplified view of the functional blocks can be seen in Figure 3-2.

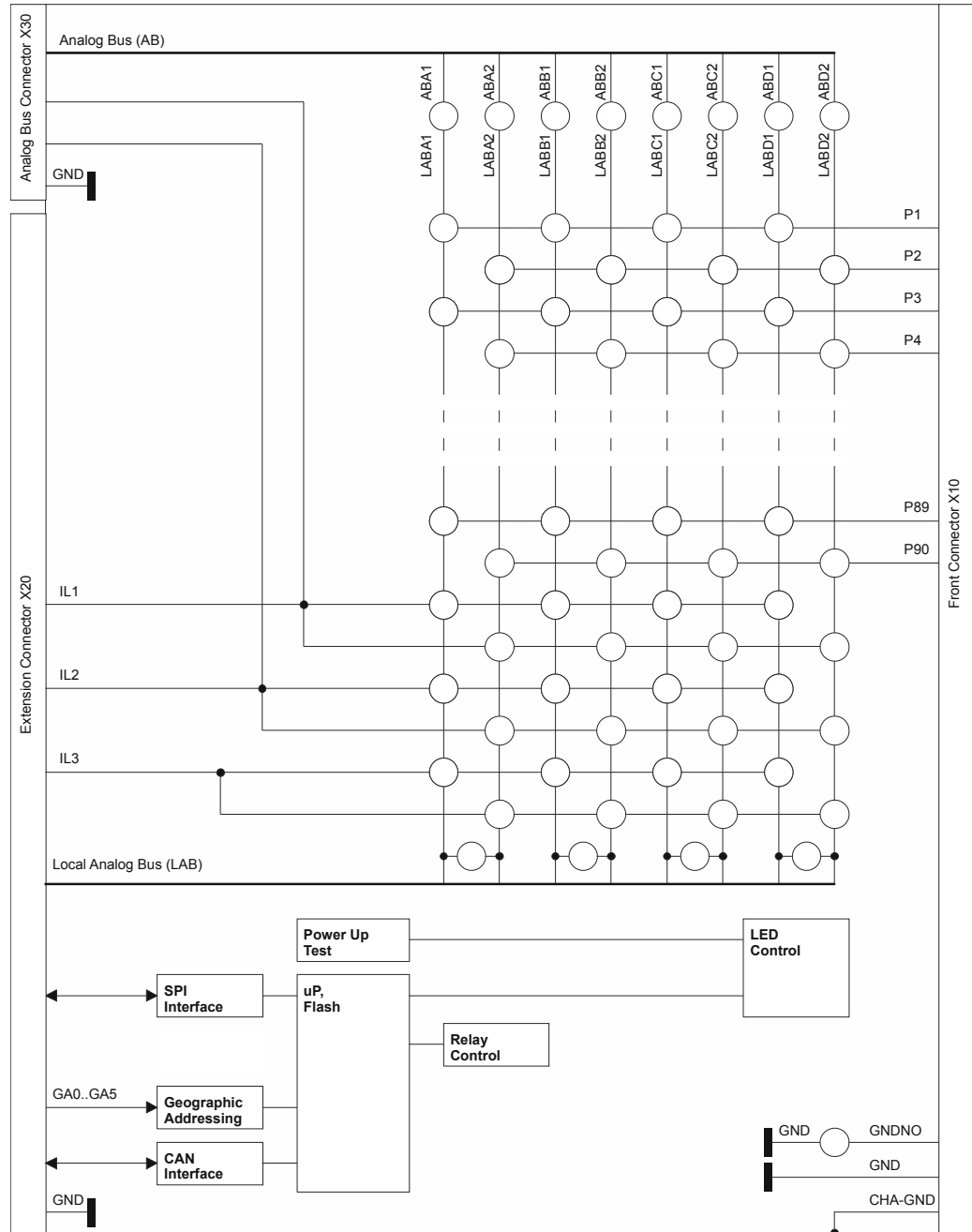

Figure 3-1: Block Diagram R&S TS-PMB

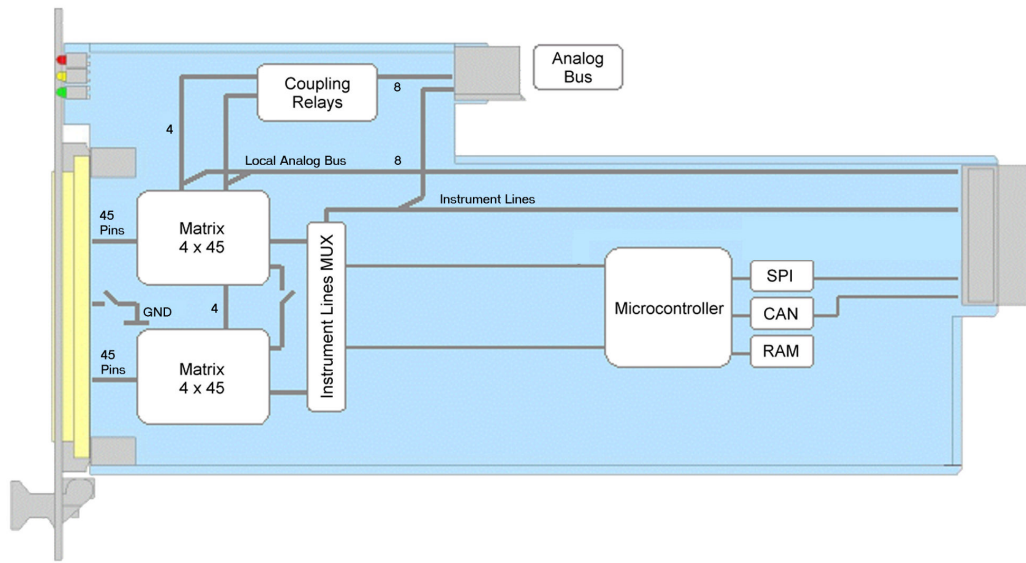

Figure 3-2: Functional Block Diagram R&S TS-PMB

4 Layout

4.1 Mechanical Layout

The R&S TS-PMB is designed as a long plug-in board for front mounting in the TSVP chassis. The mounting depth is 300 mm, and the front panel is 4U in height.

Connector X20 is used to make the connections with the cPCI backplane/control backplane of the TSVP. Connector X30 connects the R&S TS-PMB with the analog bus backplane in the TSVP chassis. UUTs and peripherals are connected using front connector X10.



Figure 4-1: Layout of Connectors and LED's

Table 4-1: Connectors on the R&S TS-PMB

| Symbol | Use |
|--------|---|
| X1 | cPCI Connector (starting with Version V3.x) |
| X10 | Front Connector |
| X20 | Extension Connector |
| X30 | Analog Bus Connector |

4.2 Display Elements

The front panel of the R&S TS-PMB contains three light-emitting diodes (LED's) with the following functions:

Table 4-2: Display elements on the R&S TS-PMB

| LED | Beschreibung |
|-----------------|--|
| ERR (red) | Fault condition: Lights up when a fault is detected on the R&S TS-PMB in the power-on test after the supply voltage is switched on. |
| COM (yellow) | Communication: Lights up briefly when the R&S TS-PMB is accessed via the interface. |
| PWR (green) | Power: Lights up when all supply voltages are present. |

5 Function Description

5.1 Signal Concept

The R&S TS-PMB allows the optional connection of measuring instruments to pins on test products. Connections can be made locally within the module or with other modules using the R&S analog bus.

The ability to connect measuring instruments to the back of the TSVP avoids cross-connections at the adapter interface. The unit's extreme compactness makes it possible to accommodate measuring systems with a number of PXI instruments and a switch panel with a large number of pins in a single device (one-box solution), making it particularly suitable for in-circuit testing.

The ground can be connected to the front connector via the ground relay (GND - GNDNO).

5.2 Scalability

The R&S TS-PMB has two switching matrices (4 x 45). These can also be configured as 8 buses x 45 pins with external connection or 4 buses x 90 pins, e.g. using plug-in module TS-PSAM via the analog bus (see [Figure 3-2](#)).

Three additional instrument inputs (IL1 ... IL3) can be used to connect measuring instruments at the rear. Up to 12 modules can be used in the CompactTSVP.

The switch panel can be divided into two 4-wire part buses for the parallel test. The number of pins can be increased with up to 16 modules adding the PowerTSVP.

5.3 Noise Immunity

The signal concept with the analog bus remote from the Compact PCI bus and the triggering via the CAN bus guarantee good signal quality. Despite the unit's compact size, DC and AC voltages up to 125 V (rms) can be connected and passed to other modules.

5.4 Relay Matrix

The matrix is designed as a part matrix, i.e. each even I/O channel (e.g. P2) can be switched to an even part bus (e.g. LABA2) and each odd I/O channel (e.g. P1) can be switched to an off part bus (e.g. LABA1) (see [Chapter 3, "Block Diagram"](#), on page 5). This does not apply to channels IL1 ... IL3, which can be switched to all lines of the local analog bus.

Coupling relays separate the local analog bus lines (LAB) on the R&S TS-PMB from the bus lines on the analog bus backplane. The firmware automatically switches these relays selectively when at least one I/O channel is switched to the corresponding local analog bus. When an I/O channel is no longer switched to a bus, the corresponding coupling relay is automatically opened. This function can be turned on or off at any time. The coupling relays can also be switched manually.

5.5 Interfaces

(see [Figure 3-2](#))

The SPI interface (Serial Peripheral Interface) is used for communication with rear I/O modules. The R&S TS-PMB is controlled via CAN interface (Controller Area Network).

5.6 Power supply

The R&S TS-PMB is operated with a voltage of 5 V. The power supply is provided through connector X20 for Versions V1.x and V2.x. In Version V3.x the power supply is provided via connector X20 or connector X1. All versions of the R&S TS-PMB can be operated in the CompactTSVP TS-PCA3 and in the PowerTSVP TS-PWA3.

Since the CompactTSVP TS-PCA3 no longer makes a 5-V power supply available on connector X20 starting with backplane Version V4.x, only R&S TS-PMB modules of Version V3.x can be operated with this backplane version. R&S TS-PMB modules of Version V2.x require a change to TAZ 2.14 and a rear IO module TS-PRIO.

6 Commissioning

To install the plug-in module, proceed as follows:

- Run down and power off the TSVP
- Remove the front panel from the rear side of the TSVP chassis by slackening off the screws

NOTICE

Damaged backplane due to bent pins

Bent pins may result in permanent damage to the backplane.

Check the backplane connector for bent pins!

Any pins that are bent must be straightened!

When module is connected, it must be guided with both hands and carefully pressed into the backplane connector.

-
- Insert the plug-in module using moderate pressure.
 - The top snap pin on the module must locate in the right-hand and the bottom pin in the left-hand hole on the TSVP chassis.
 - The plug-in module is correctly located when a distinct 'stop' can be felt
 - Tighten the top and bottom screws on the front panel of the plug-in module



(starting with CompactTSVP TS-PCA3 with backplane version V4.x)

Matrix modules B R&S TS-PMB with change status V2.x (recognisable from the lack of connector X1) require a hardware change to TAZ 2.14 and a Rear IO Module TS-PRIO plugged in to operated in the CompactTSVP TS-PCA3 with backplane version V4.x (starting with serial number 100109). The 5-V power supply and CAN bus are supplied via the TS-PRIO.

7 Software

7.1 Driver Software

A LabWindows CVI driver is provided for the R&S TS-PMB . This driver satisfies the IVI Switch specification. The driver is part of the ROHDE & SCHWARZ GTSL software. All the functions of the driver are described fully in the on-line help.

During driver installation, the following software modules are installed:

Table 7-1: Driver Installation R&S TS-PMB

| Module | Path | Comment |
|-------------|------------------------------|---|
| rspmb.dll | <GTSL directory>\Bin | Driver |
| / rspmb.chm | <GTSL directory>\Bin | Help files |
| rspmb.fp | <GTSL directory>\Bin | LabWindows CVI Function Panel file, function panels for CVI development interface |
| rspmb.sub | <GTSL directory>\Bin | LabWindows CVI attribute file. This file is required by some „function panels“. |
| rspmb.lib | <GTSL directory>\Bin | Import Library |
| rspmb.h | <GTSL directory>\ Include | Header file for the driver |



To use the driver, the IVI and VISA libraries from National Instruments are necessary.

7.2 Softpanel

The software package of the R&S TS-PMB includes a softpanel (see example in [Figure 7-1](#)). The softpanel enables the user to execute the functions of the R&S TS-PMB listed in the menu with on-screen mouse clicks.

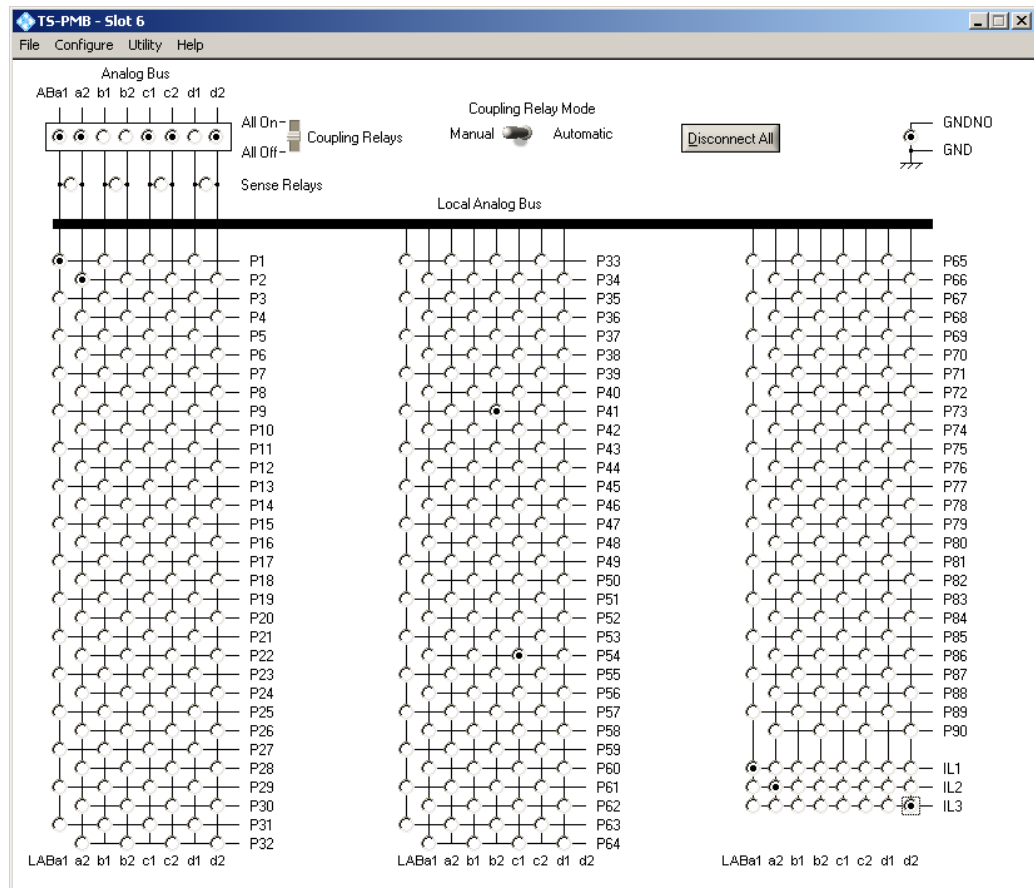

Figure 7-1: Softpanel R&S TS-PMB (example)

7.3 TS-PMB Program Example

```

/*
   Connection between ABa1 and ABb1 with TS-PMB in Slot 12

   The coding rules of a GTSL software like
   allocating and locking the resource, or error handling
   are not considered in this example.
   It's just to show the function calls to get the connection.
*/

/*
   rspmb ivi-driver header file
*/

#include "rspmb.h"

static ViStatus      s_status;

```

```
main()
{
    /*
     * Creates a new IVI instrument driver and optionally sets the initial
     * state of the session attributes
     *
     * "CAN0::0::1::12": CAN board 0, Bus Controller 0, Frame 1, Slot 12
     */
    s_status = rspmb_InitWithOptions ("CAN0::0::1::12", VI_TRUE, VI_TRUE, "", & handle);

    /*
     * This function sets/opens automatically the bus coupling relays
     * (local analog bus to analog bus) if a path is created/closed.
     */
    s_status = rspmb_SetAttributeViBoolean (handle, "", RSPMB_ATTR_CR_AUTO, VI_TRUE);
    /*
     * This function creates a path between channel ABa1 and P1.
     * The driver calculates the shortest path between the two channels.
     */
    s_status = rspmb_Connect (handle, "ABa1", "P1");
    s_status = rspmb_Connect (handle, "ABb1", "P1");

    /*
     * Connection between ABa1 and ABb1 exists.
     */
    /*
     * Opens the path between Channel ABa1 and LABa1.
     */
    s_status = rspmb_Disconnect (handle, "ABa1", "P1");
    s_status = rspmb_Disconnect (handle, "ABb1", "P1");

    s_status = rspmb_close (handle);
}
```

8 Self-Test

The R&S TS-PMB has a built-in self-test capability. The following tests are implemented:

- LED-Test
- Power-on test
- TSVP Self-Test

8.1 LED Test

After power-on, all three LED's light up for around three seconds to indicate that the 5 V supply is present and all LED's are working. The following statements can be made about the different LED states:

Table 8-1: Statements about the LED Test

| LED | Description |
|---------------------------|--|
| One LED does not light up | Hardware problem on the module LED faulty |
| No LED's light up | No +5 V supply |

8.2 Power-On Test

The power-on test runs at the same time as the LED test. The red LED lights up if a fault is found on the module. This is just a test of the command interface and the firmware of the R&S TS-PMB.

8.3 TSVP Self-Test

The TSVP self-test runs an in-depth test on the module and generates a detailed log.

The TS-PSAM modules is used as a measuring unit of R&S modules in the TSVP. The correct operation of the modules is ensured by measurements on the analog bus.



You can find information about starting the self-test and the order of required work steps as well as a detailed description of parameters and sequences that are tested in the *R&S CompactTSVP / R&S Power TSVP Service Manual*.

9 Interface description

9.1 Connector X10

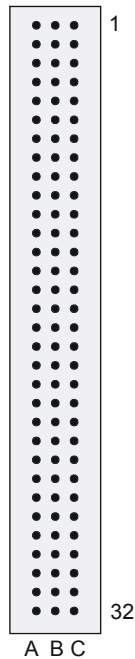

Figure 9-1: Connector X10 (mating side)

Table 9-1: X10 Pinning Schedule

| Pin | A | B | C |
|-----|-----|-----|-----|
| 1 | P1 | P33 | P65 |
| 2 | P2 | P34 | P66 |
| 3 | P3 | P35 | P67 |
| 4 | P4 | P36 | P68 |
| 5 | P5 | P37 | P69 |
| 6 | P6 | P38 | P70 |
| 7 | P7 | P39 | P71 |
| 8 | P8 | P40 | P72 |
| 9 | P9 | P41 | P73 |
| 10 | P10 | P42 | P74 |
| 11 | P11 | P43 | P75 |
| 12 | P12 | P44 | P76 |
| 13 | P13 | P45 | P77 |

| Pin | A | B | C |
|-----|-----|-----|---------|
| 14 | P14 | P46 | P78 |
| 15 | P15 | P47 | P79 |
| 16 | P16 | P48 | P80 |
| 17 | P17 | P49 | P81 |
| 18 | P18 | P50 | P82 |
| 19 | P19 | P51 | P83 |
| 20 | P20 | P52 | P84 |
| 21 | P21 | P53 | P85 |
| 22 | P22 | P54 | P86 |
| 23 | P23 | P55 | P87 |
| 24 | P24 | P56 | P88 |
| 25 | P25 | P57 | P89 |
| 26 | P26 | P58 | P90 |
| 27 | P27 | P59 | GNDNO |
| 28 | P28 | P60 | GNDNO |
| 29 | P29 | P61 | GNDNO |
| 30 | P30 | P62 | GND |
| 31 | P31 | P63 | GND |
| 32 | P32 | P64 | CHA-GND |



Signal CHA-GND (chassis GND) is connected to the front panel of the R&S TS-PMB.

9.2 Connector X20

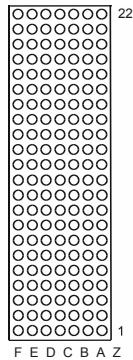
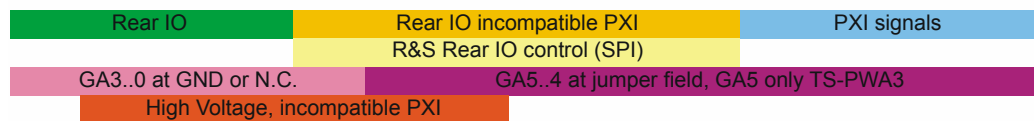

Figure 9-2: Connector X20 (mating side)

| Pin | F | E | D | C | B | A | Z | |
|-----|----|-----------|------------|-----------|-----------|-----------|----|--|
| 22 | | GA0 | GA1 | GA2 | GA3 | GA4 | | X20 C O N N E C T O R |
| 21 | | PXI_LBR3 | PXI_LBR2 | PXI_LBR1 | GA5 | PXI_LBR0 | | |
| 20 | | PXI_LBL1 | GND | PXI_LBL0 | AUX1 | AUX2 | | |
| 19 | | AUX1 | AUX2 | PXI_LBL3 | GND | PXI_LBL2 | | |
| 18 | | PXI_TRIG6 | GND/NC *1) | PXI_TRIG5 | PXI_TRIG4 | PXI_TRIG3 | | |
| 17 | | PXI_CLK10 | AUX4 | AUX3 | GND | PXI_TRIG2 | | |
| 16 | | PXI_TRIG7 | GND | AUX5 | PXI_TRIG0 | PXI_TRIG1 | | |
| 15 | | +5V | +5V | AUX6 | GND | | | |
| 14 | NC | | | | | | NC | |
| 13 | NC | | | | | | NC | |
| 12 | NP | LABA1 | | | | LABC1 | NP | |
| 11 | NP | | | IL1 | | | NP | |
| 10 | NC | LABB1 | | | | LABD1 | NC | |
| 9 | NC | | | IL3 | | | NC | |
| 8 | NC | LABA2 | | | | LABC2 | NC | |
| 7 | NC | | | IL2 | | | NC | |
| 6 | NC | LABB2 | | | | LABD2 | NC | |
| 5 | NC | | | | | | NC | |
| 4 | NC | | | | | | NC | |
| 3 | | RSA0 | RRST# | +12V | GND | RSDO | | |
| 2 | | +12V | RSDI | RSA1 | +5V | RSCLK | | |
| 1 | | +5V | CAN_L | CAN_H | GND | RCS# | | |
| Pin | F | E | D | C | B | A | Z | |



*1) N.C. only in V2.14 (special requirement for use in TS-PCA3 backplane V4.x, additionally rear-IO-module TS-PRIO required)

Figure 9-3: X20 Pinning Schedule (Version 2.X)

| Pin | F | E | D | C | B | A | Z | |
|-----|----|-----------|----------------------|-----------|-----------|-----------|----|--|
| 22 | | GA0 | GA1 | GA2 | GA3 | GA4 | | X20 C O N N E C T O R |
| 21 | | | | | GA5 | | | |
| 20 | | | GND | | AUX1 | AUX2 | | |
| 19 | | AUX1 | AUX2 | | GND | -12V | | |
| 18 | | PXI_TRIG6 | GND / CAN_EN in V3.0 | PXI_TRIG5 | PXI_TRIG4 | PXI_TRIG3 | | |
| 17 | | PXI_CLK10 | | | GND | PXI_TRIG2 | | |
| 16 | | PXI_TRIG7 | GND | | PXI_TRIG0 | PXI_TRIG1 | | |
| 15 | | | +5V | | GND | | | |
| 14 | NC | | | | | | NC | |
| 13 | NC | | | | | | NC | |
| 12 | NP | LABA1 | | | | LABC1 | NP | |
| 11 | NP | | | IL1 | | | NP | |
| 10 | NC | LABB1 | | | | LABD1 | NC | |
| 9 | NC | | | IL3 | | | NC | |
| 8 | NC | LABA2 | | | | LABC2 | NC | |
| 7 | NC | | | IL2 | | | NC | |
| 6 | NC | LABB2 | | | | LABD2 | NC | |
| 5 | NC | | | | | | NC | |
| 4 | NC | | | | | | NC | |
| 3 | | RSA0 | RRST# | | GND | RSDO | | |
| 2 | | +12V | RSDI | RSA1 | | RSCLK | | |
| 1 | | +5V | CAN_L | CAN_H | GND | RCS# | | |
| Pin | F | E | D | C | B | A | Z | |

Figure 9-4: X20 Pinning Schedule (Version 3.X)

9.3 Connector X1 (only Version 3.x)

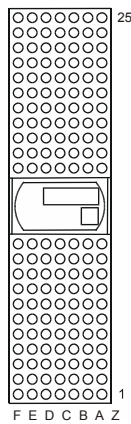

Figure 9-5: Connector X1 (mating side)

| Pin | F | E | D | C | B | A | Z | | |
|--------|-----|---------|---------|---|---------|---------|---|---|--|
| 25 | GND | +5V_IN2 | | | | +5V_IN2 | | X1 C O N N E C T O R | |
| 24 | GND | | | | +5V_IN2 | | | | |
| 23 | GND | | +5V_IN2 | | | | | | |
| 22 | GND | | | | GND | | | | |
| 21 | GND | | | | | | | | |
| 20 | GND | | | | GND | | | | |
| 19 | GND | | GND | | | | | | |
| 18 | GND | | | | GND | | | | |
| 17 | GND | | GND | | | | | | |
| 16 | GND | | | | GND | | | | |
| 15 | GND | | GND | | | | | | |
| 12..14 | | | | | | | | | |
| 11 | GND | | GND | | | | | | |
| 10 | GND | | | | GND | | | | |
| 9 | GND | | GND | | | | | | |
| 8 | GND | | | | GND | | | | |
| 7 | GND | | GND | | | | | | |
| 6 | GND | | | | GND | | | | |
| 5 | GND | | GND | | | | | | |
| 4 | GND | | | | GND | | | | |
| 3 | GND | | +5V_IN1 | | | | | | |
| 2 | GND | | | | +5V_IN1 | | | | |
| 1 | GND | +5V_IN1 | +12V | | -12V | +5V_IN1 | | | |
| Pin | F | E | D | C | B | A | Z | | |

Figure 9-6: X1 Pinning Schedule

9.4 Connector X30

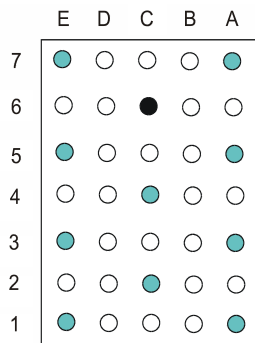

Figure 9-7: Connector X30 (mating side)

Table 9-2: X30 Pinning Schedule

| Pin | E | D | C | B | A |
|-----|------|---|------|---|------|
| 7 | IL2 | | | | IL1 |
| 6 | | | GND | | |
| 5 | ABC1 | | | | ABA1 |
| 4 | | | ABB1 | | |

| Pi n | E | D | C | B | A |
|---------|------|---|------|---|------|
| 3 | ABC2 | | | | ABB2 |
| 2 | | | ABA2 | | |
| 1 | ABD2 | | | | ABD1 |



IL1_x = IL1 of the slot

10 Specifications

NOTICE

The technical data of the Matrix Module B R&S TS-PMB are shown in the corresponding data sheets.

In the event of any discrepancies between data in this user manual and technical data in the data sheet, the data sheet takes precedence.
